

Participation in the Heliospheric Network: Virtual modelling and simulation of the HI-SCALE instrument aboard the Ulysses spacecraft

**Bruno
Morgado**

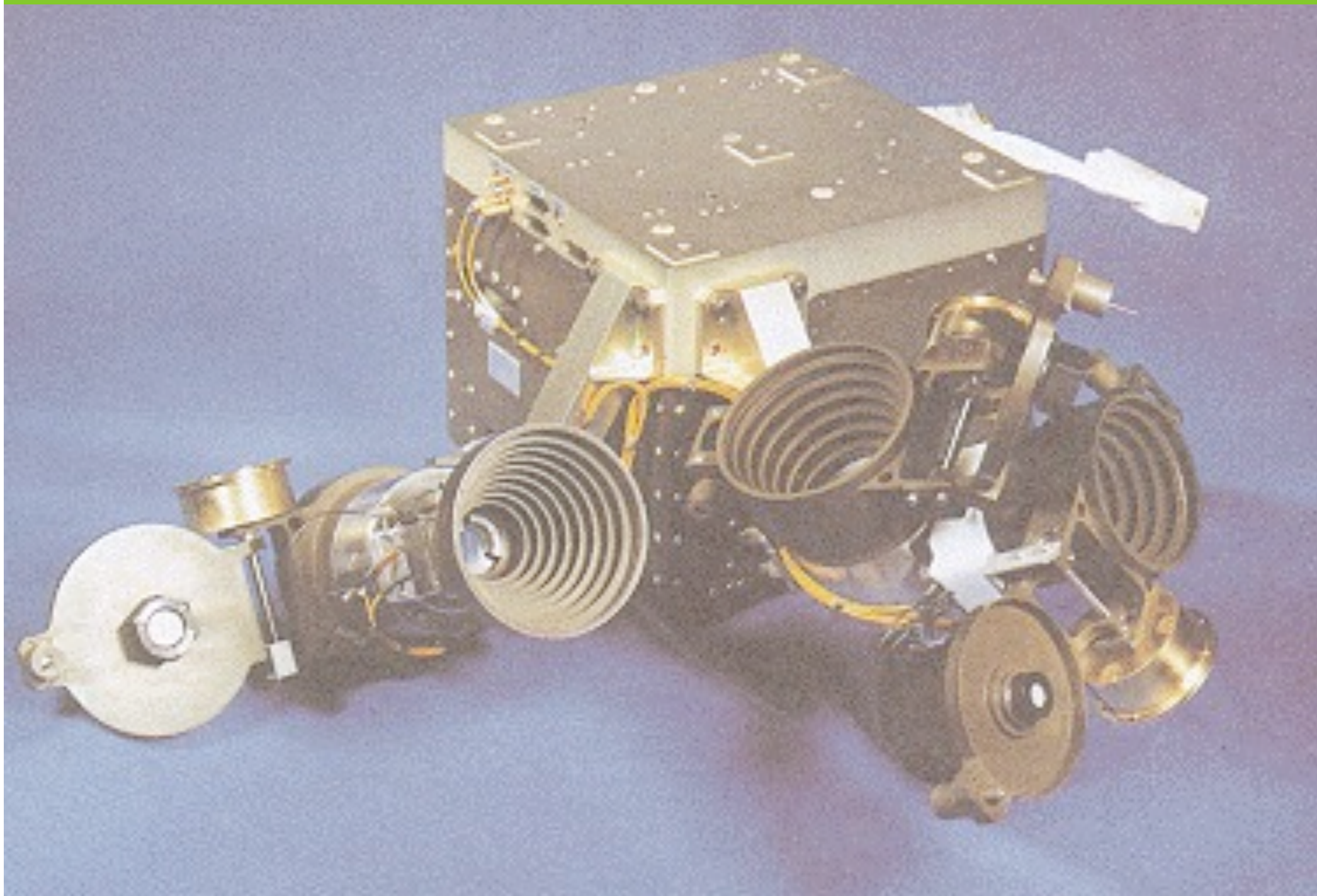

Heliospheric network

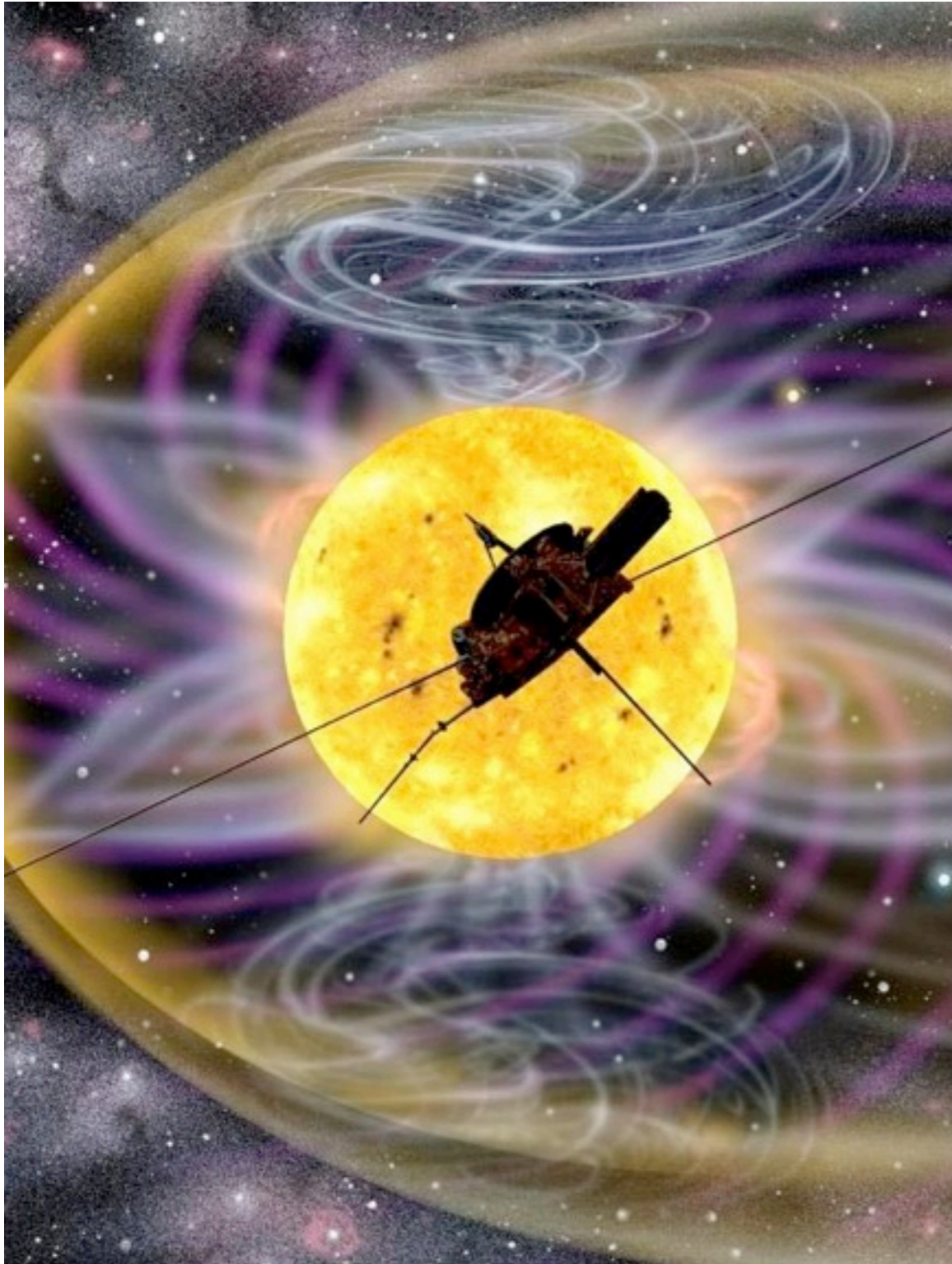

- The heliospheric network is a dedicated group of researchers addressing the challenges and puzzles raised by the data collected in the previous and present solar cycles by the extended and expanded set of heliospheric missions.



Heliospheric network missions

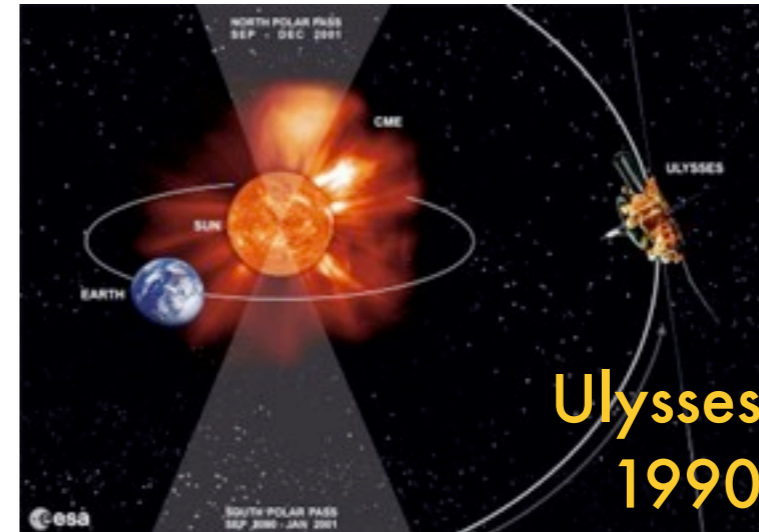
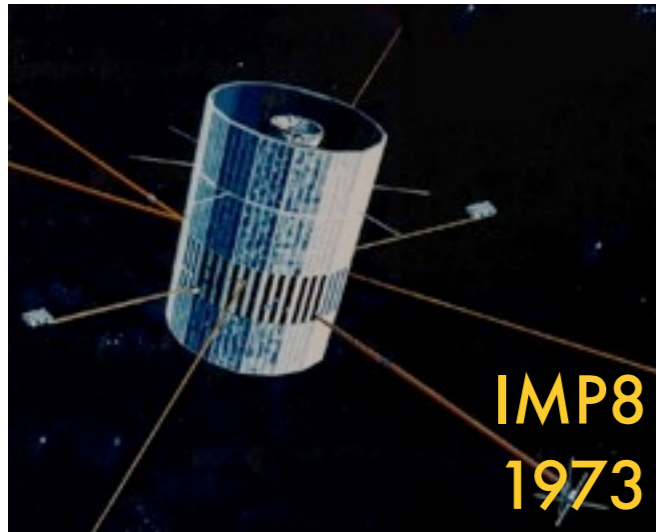

Space radiation environment

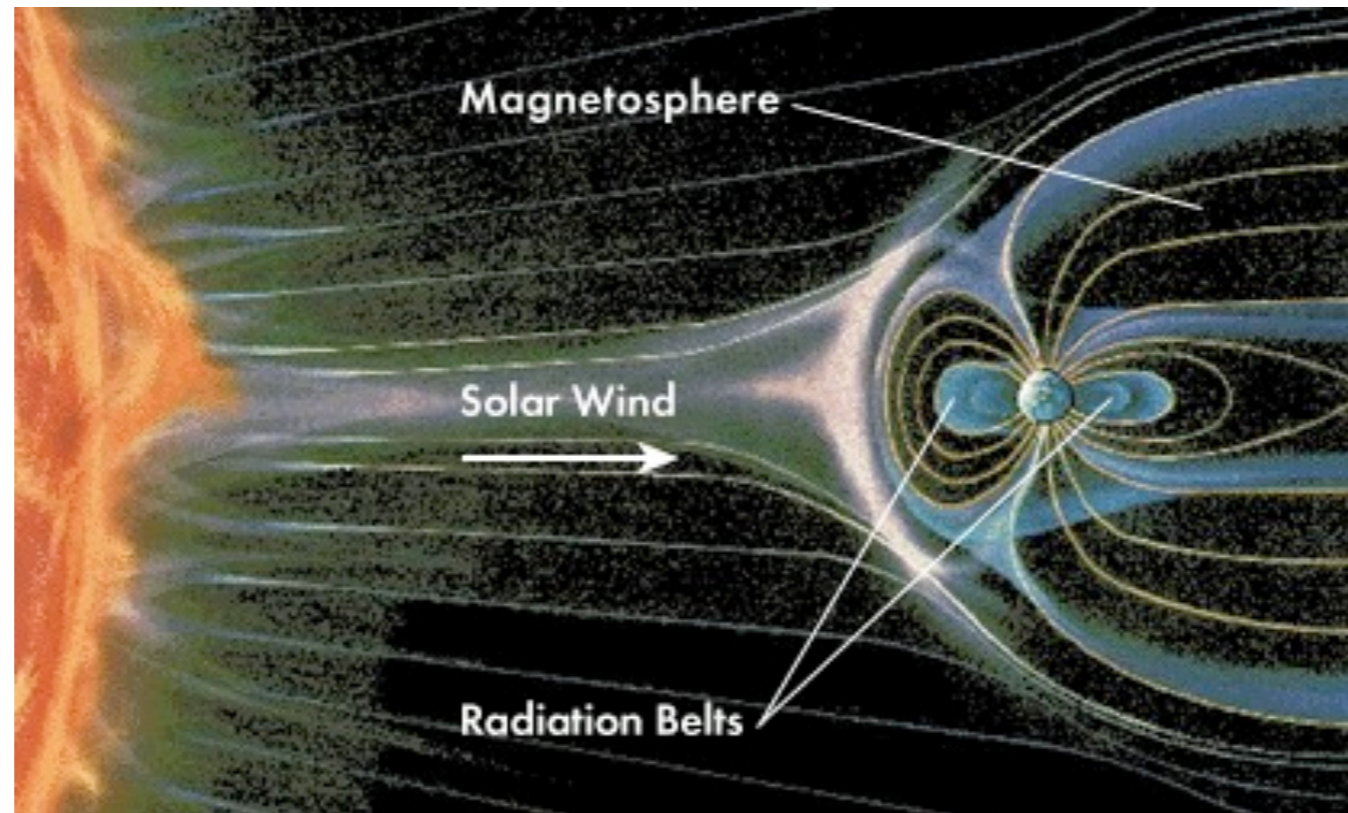

- Earth's trapped radiation belts.
- Galactic Cosmic Rays.
- Solar Energetic Particles (SEP):
 - Associated with impulsive solar flares and Coronal Mass Ejections;
 - Sudden and dramatic increase in flux. Unpredictable & highly variable;
 - Mostly "low energy" electrons & protons;
 - Frequency and magnitude strongly correlated with solar cycle.

Measuring where no probe measured before

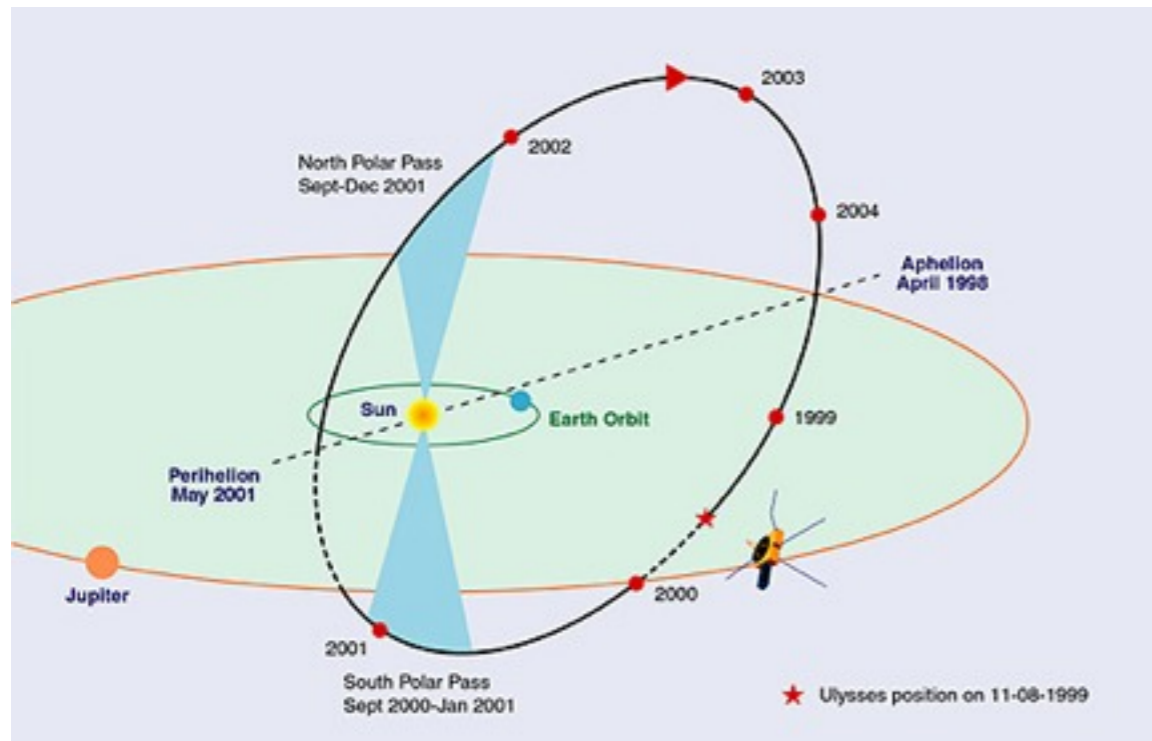

- The Ulysses translates around the Sun in a polar orbit.
- The ACE revolves about the lagrangian L_1 point.
- Comparison between the measured properties of SEP at different points in the heliosphere from a complete solar cycle using data from the HI-SCALE and EPAM instrument aboard Ulysses and ACE missions.

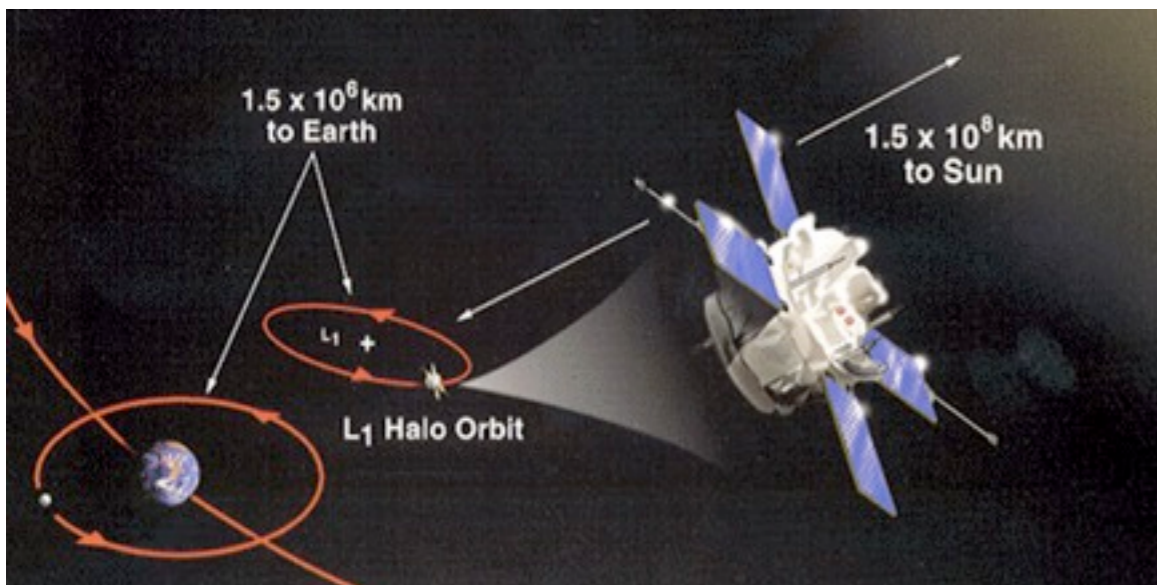

The HI-SCALE and EPAM

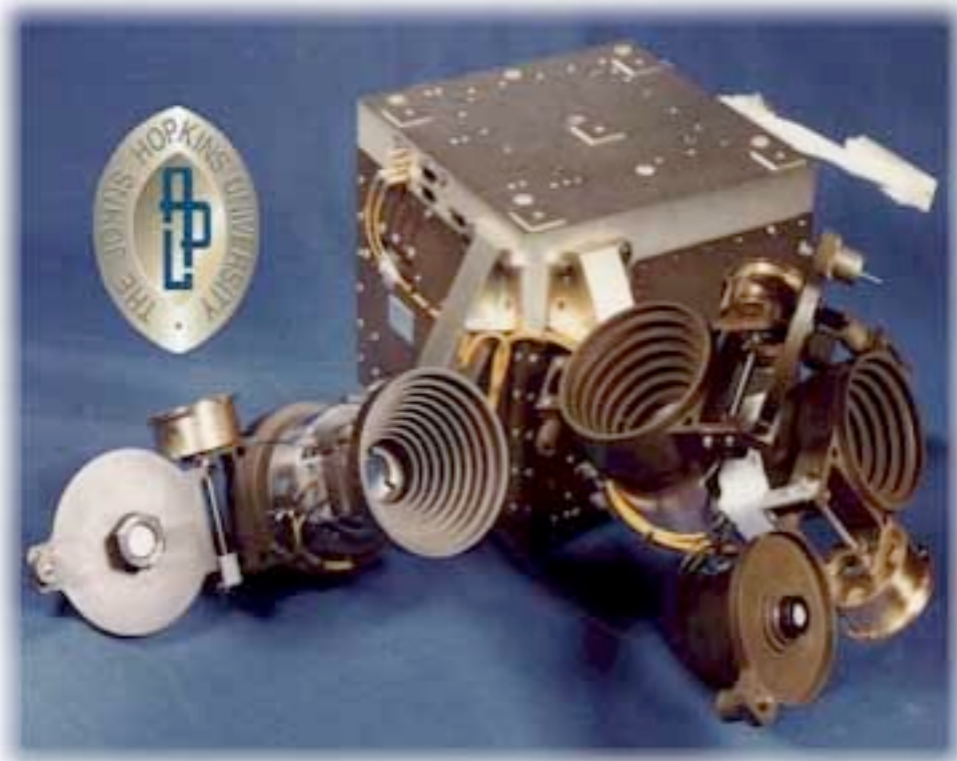

- The HI-SCALE aboard Ulysses and the EPAM aboard ACE are similar instruments.
- They are of quite dated technology and when sent to space there was no method to thoroughly simulate and calibrate them.

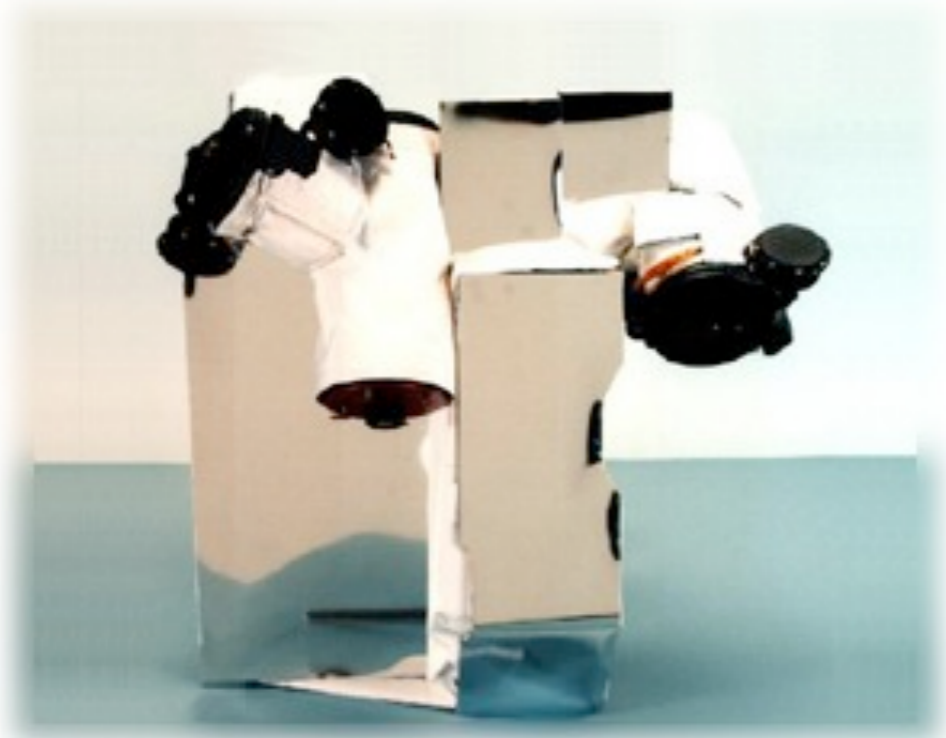

HI-SCALE Instrument

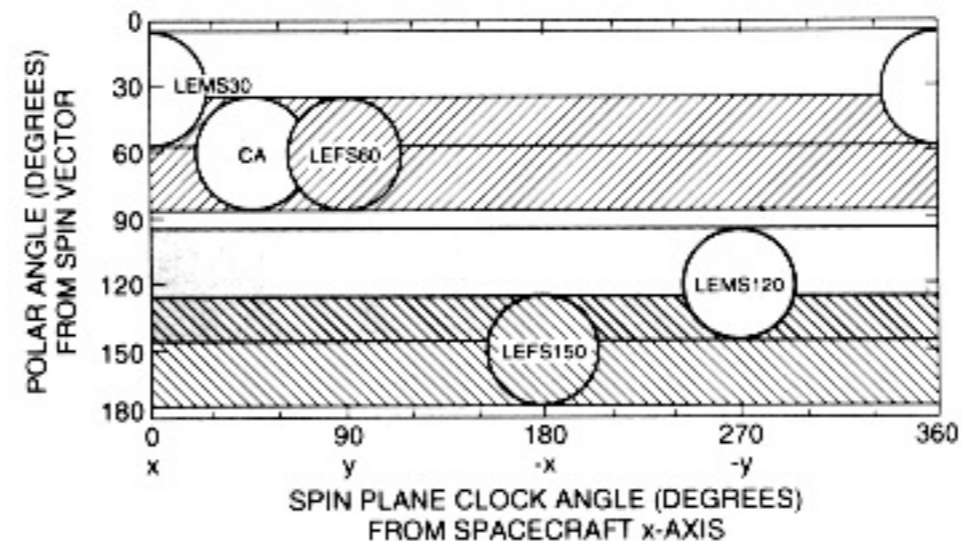

- Heliosphere Instrument for Spectra, Composition and Anisotropy at Low Energies.
- Objectives: Make measurements of interplanetary ions and electrons through the entire Ulysses mission.
- Detects ions of $E_i \geq 50$ keV and electrons of $E_e \geq 30$ keV.
- Has a coverage of practically 4π srad over a turn (~ 12 s).
- Ion elemental abundances can be determined by an ΔE vs E telescope.



HI-SCALE components

- It's composed of 5 main elements.
- The LEFS detects electrons of $E_e \geq 30$ keV in a silicon detector while stopping ions of $E_i \leq 350$ keV with a parylene foil.
 - The electronics will discard electrons with $E_e > 300$ keV.
- The LEMS detects ions of $E_i \geq 50$ keV in a silicon detector while deflecting electrons of $E_e \leq 300$ keV using a strong magnetic field.
- The CA works as a ΔE vs E detector analysing both the electrons swept away from the LEMS30 and the particles that enter the detector trough the front.

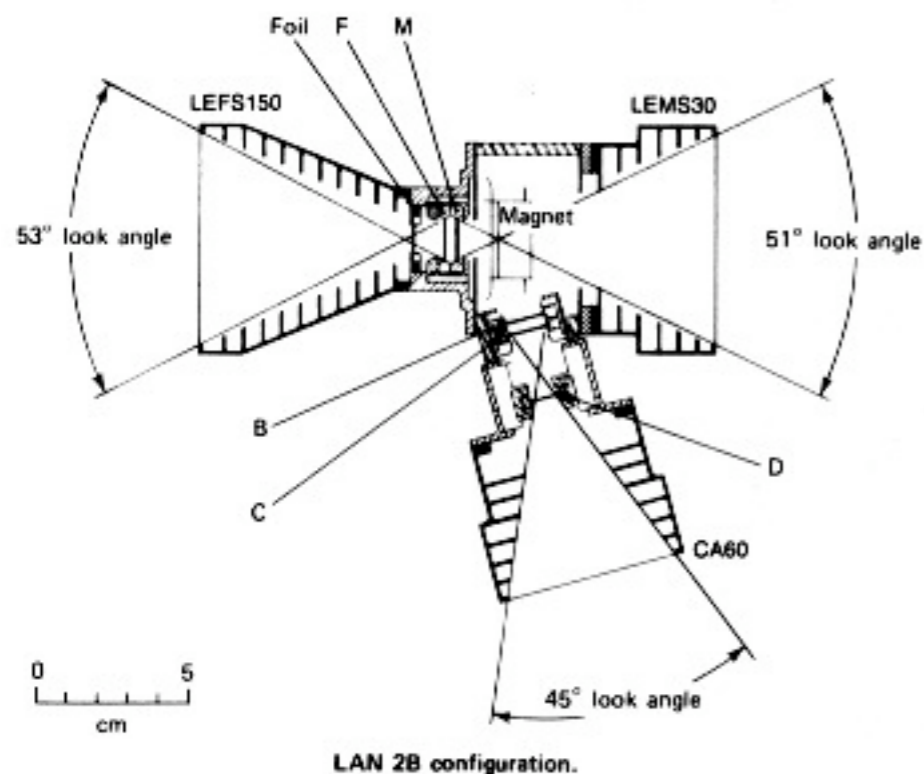
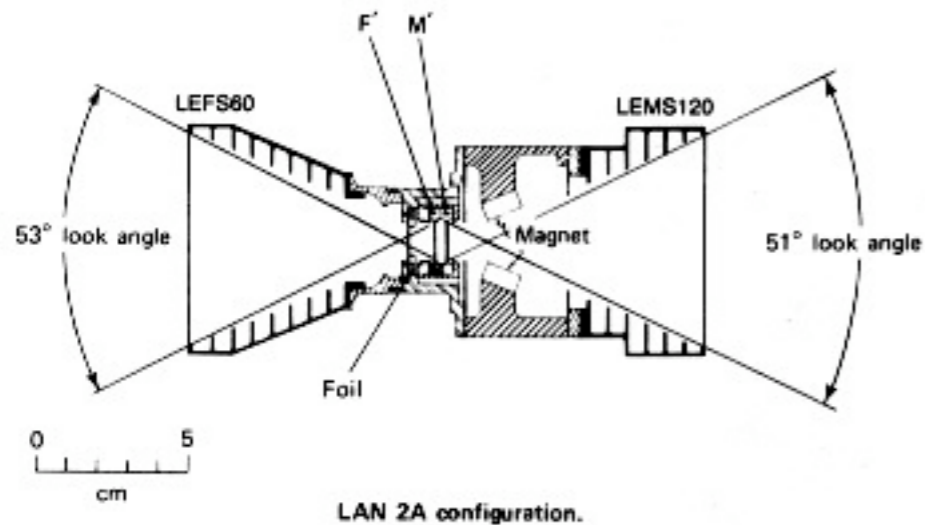

Importance of the simulation

- By comparing known fluxes at key events with the read fluxes on the HI-SCALE instrument and the ones in the GEANT4 simulation, one will be able to suppress possible sources of contamination.
- This will allow the removal of systematic effects in the average anisotropies.
- By inputting a model of the 23rd solar cycle in the simulation and checking the virtual detector response, one will be able to better plan the detectors to future similar missions.
- Description of SEP characteristics in different locations of the heliosphere.
- Requirements for radiation monitors to fly on future heliospheric missions.



GEANT4

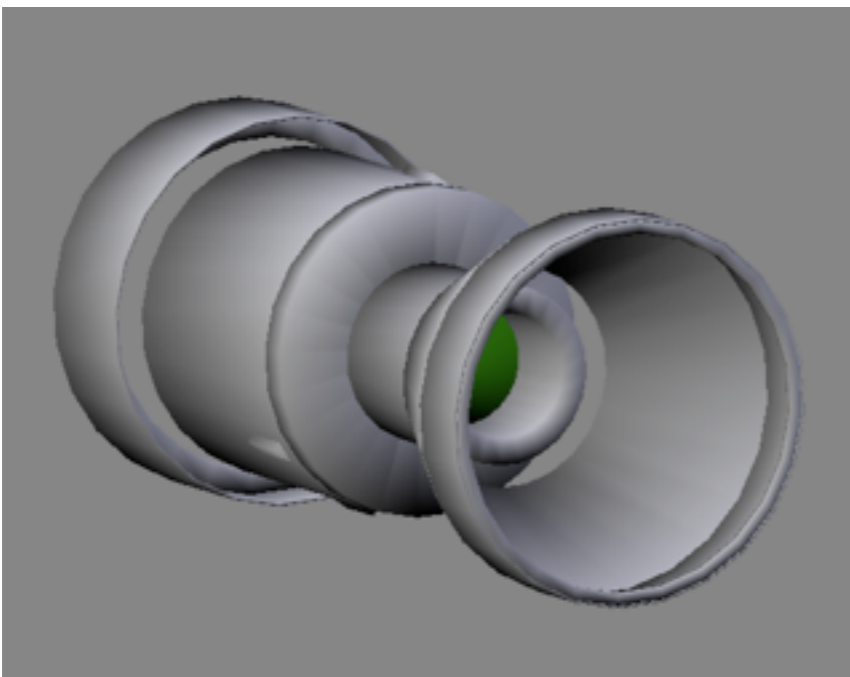
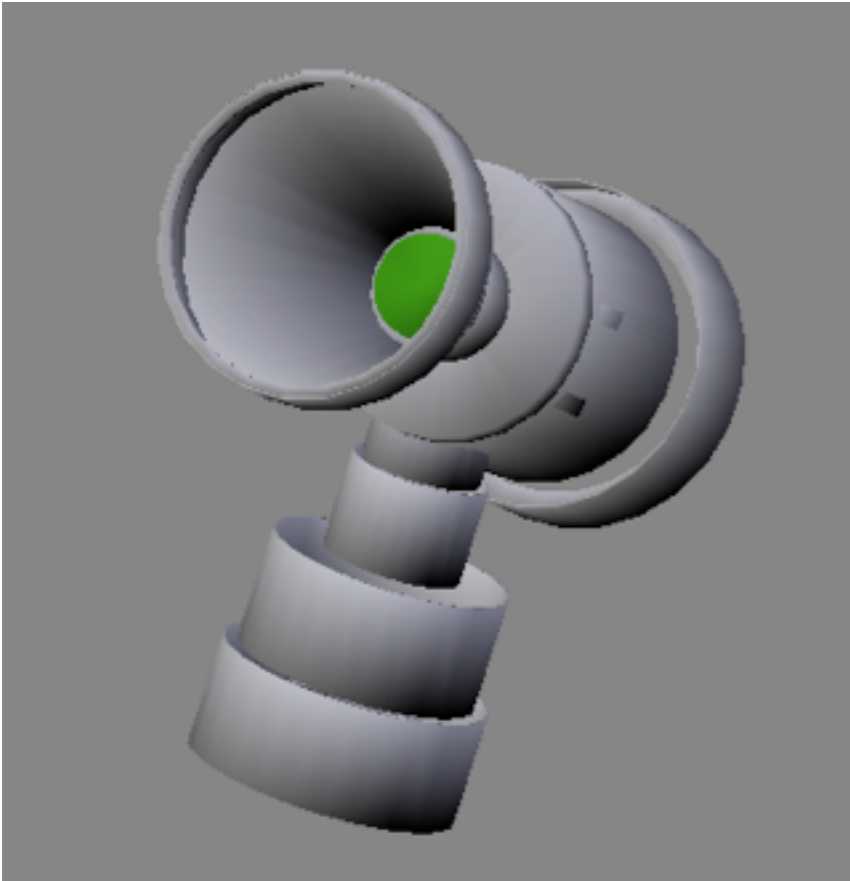

- GEANT4 is a toolkit for the simulation of the passage of particles through matter. Its areas of application include high energy, nuclear and accelerator physics, as well as studies in medical and space science.
- It allows us to create a virtual model of a given detector in order to carry out simulations with it.
- The full instrument was thoroughly simulated with GEANT4.
- More than 1600 lines of C++ code were needed to describe the all instrument.



Implementation and code structure

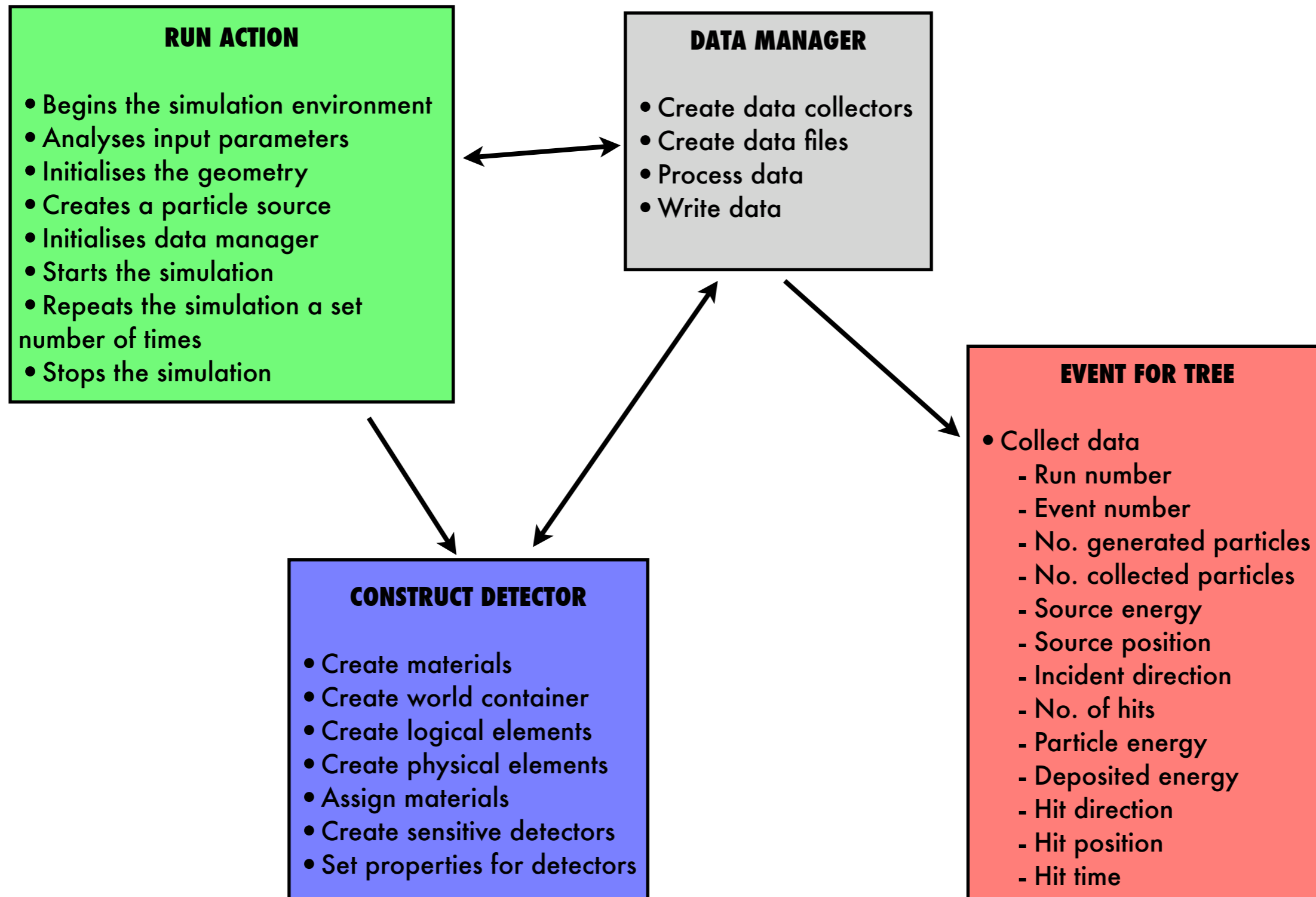

Expected results - LEFS

	Channel	Logic	Passband ^a	Sectors	Accum. time(s) @ 1024 bit/s
LEFS 150 ^b	E1	F1 $\overline{F2}$ \overline{M}	30-50 keV electrons	4 ^b , 8 ^c	3 ^b , 1.5 ^c
(M, F)	E2	F2 $\overline{F3}$ \overline{M}	50-90 keV electrons	4 ^b , 8 ^c	3 ^b , 1.5 ^c
LEFS 60 ^c	E3	F3 $\overline{F4}$ \overline{M}	90-165 keV electrons	4 ^b , 8 ^c	3 ^b , 1.5 ^c
(M', F')	E4	F4 $\overline{F5}$ \overline{M}	165-300 keV electrons	4 ^b , 8 ^c	3 ^b , 1.5 ^c
~ 0.48 cm ² sr	FP5	F5 $\overline{F6}$ \overline{M}	300-550 keV ions	4 ^b , 8 ^c	6 ^b , 3 ^c
	FP6	F6 $\overline{F7}$ \overline{M}	550-1.0 MeV ions	4 ^b , 8 ^c	6 ^b , 3 ^c
	FP7	F7 \overline{M}	1.0-5.0 MeV ions	4 ^b , 8 ^c	6 ^b , 3 ^c
Singles	S1	Det. B,C,D			12
	S2	Det. M,F,M',F'			12



Electron energy deposited in F' Calibration

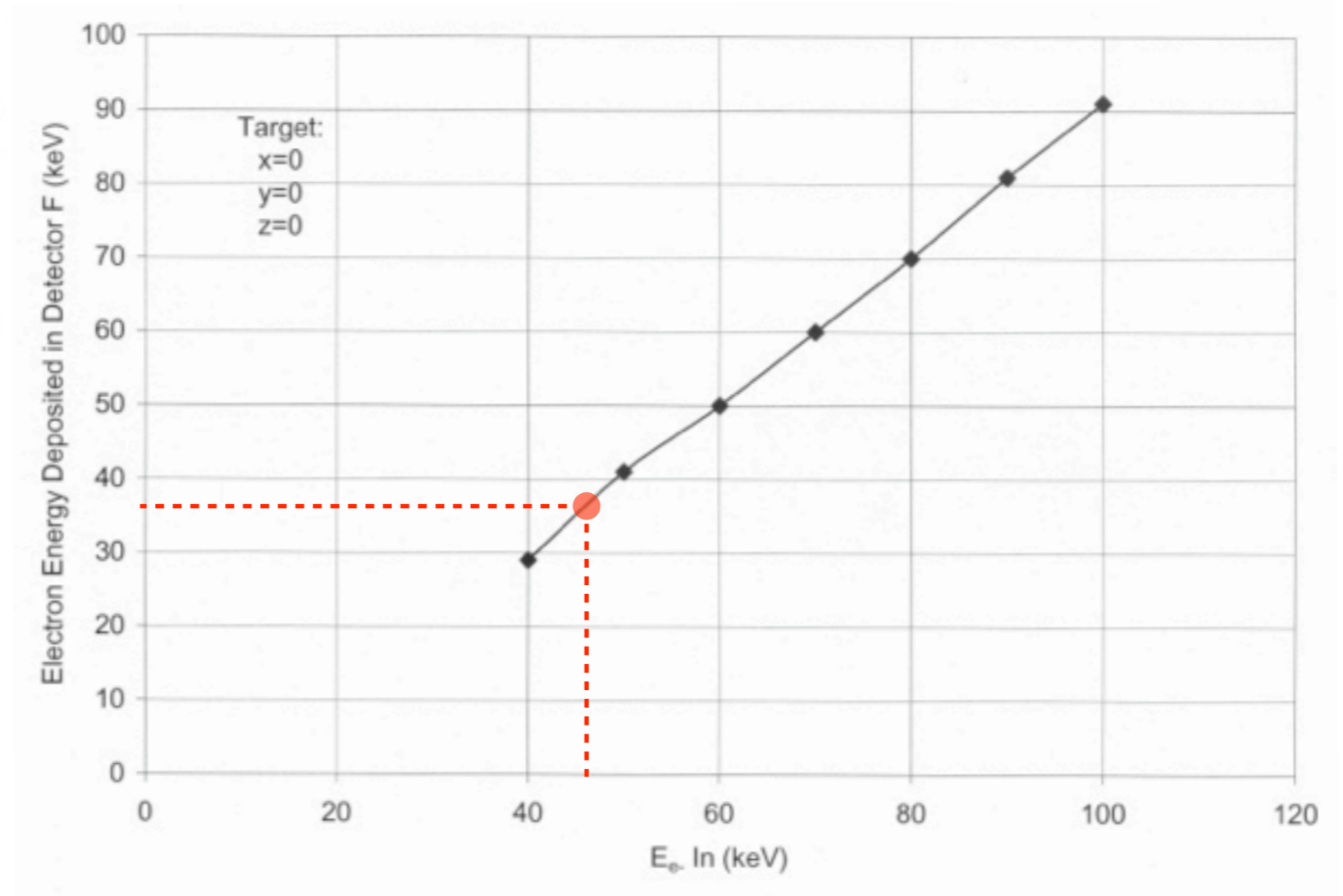
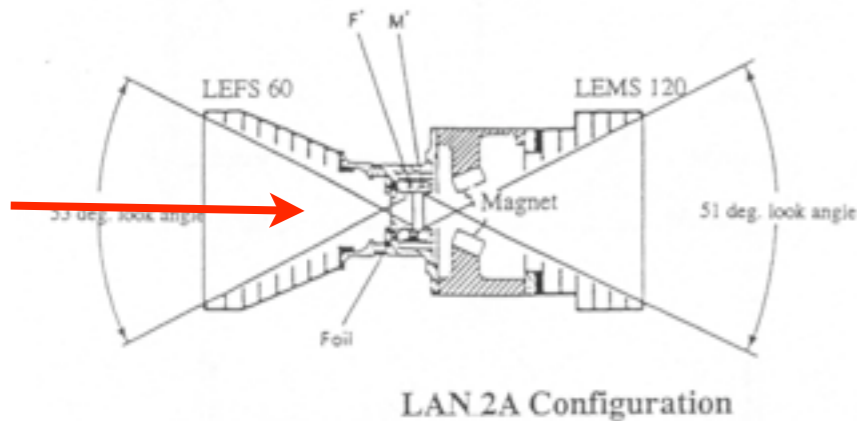

- The original calibration was achieved by directing a very narrow beam with specific energies at the centre of the detector.
- Notice that throughout the all presented range there is a loss of approximately 10 keV at every energy input due to the foil.

Detector F' in LEFS *Simulation*

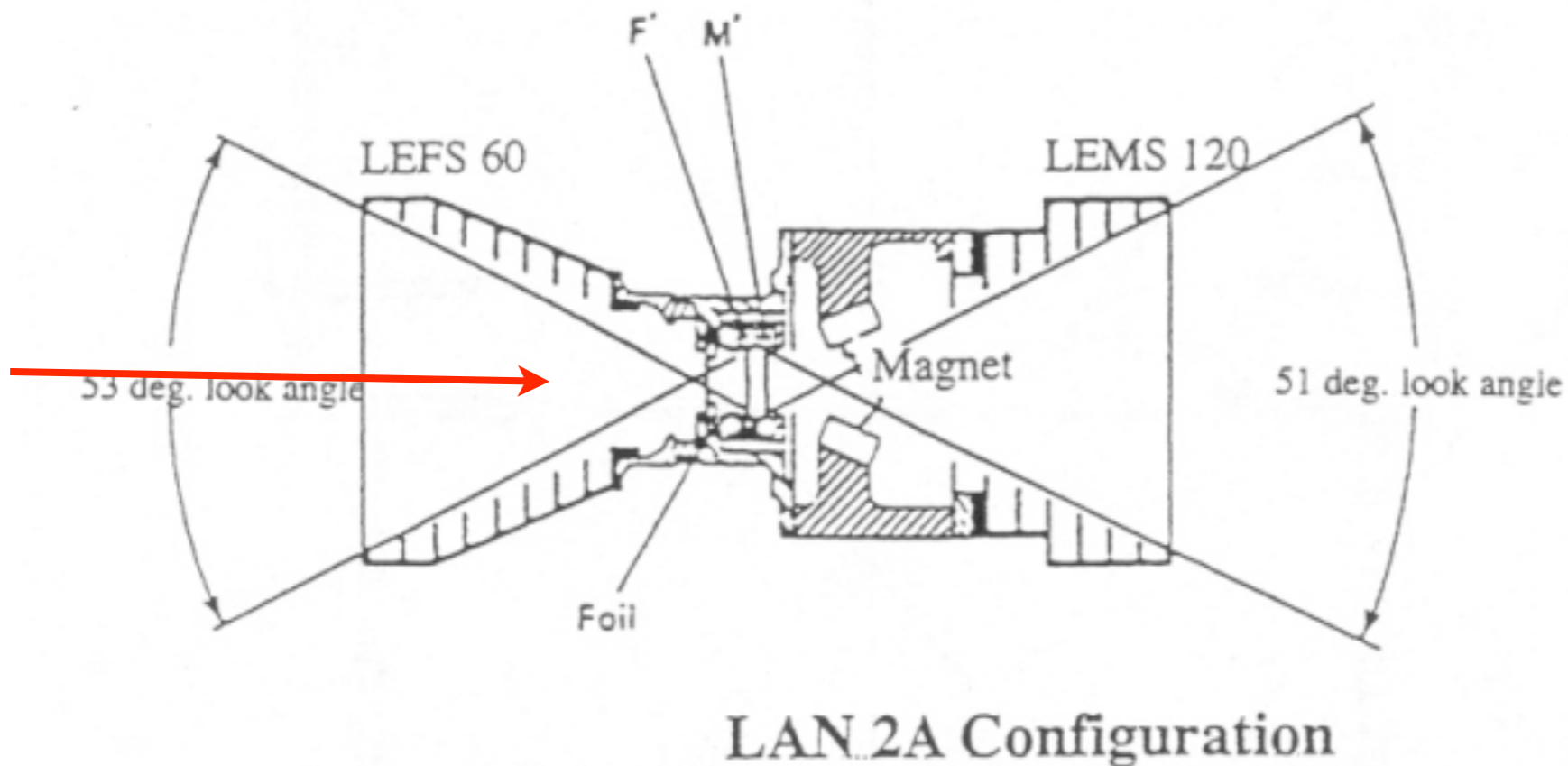

- 0 to 160 keV electron beam perpendicular to the foil directed at the centre of the detector.

Detector F' in LEFS

Effect of the Foil in the Deposited Energy

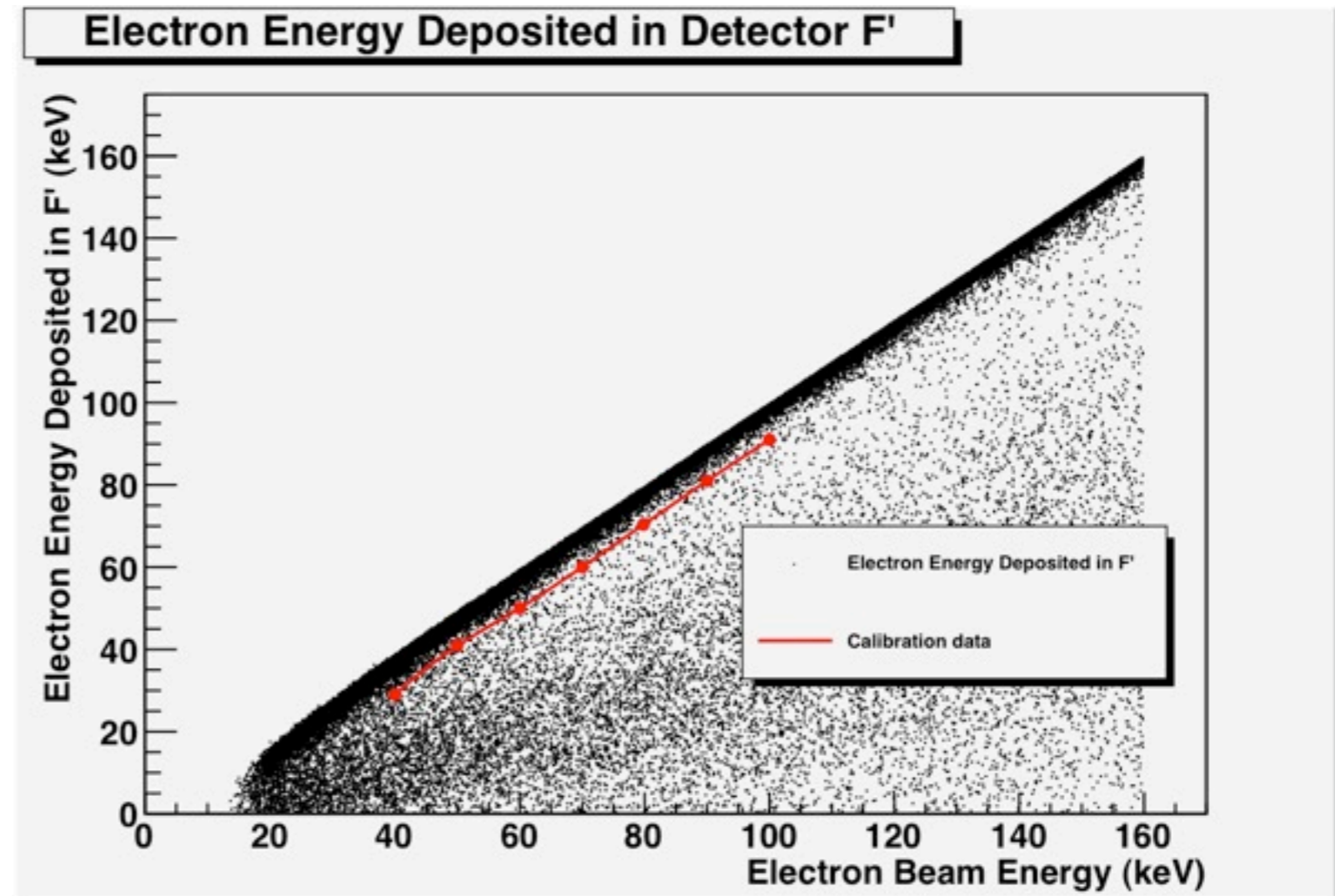
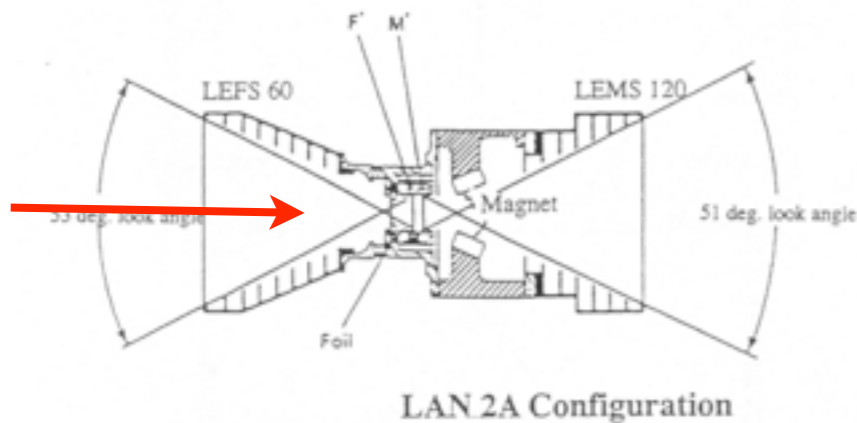

- The GEANT4 simulation reproduces the calibration data for the deposited energy in detector F.
- Electrons lose energy in the Foil.

Detector F' in LEFS

Effect of the Foil in the Deposited Energy

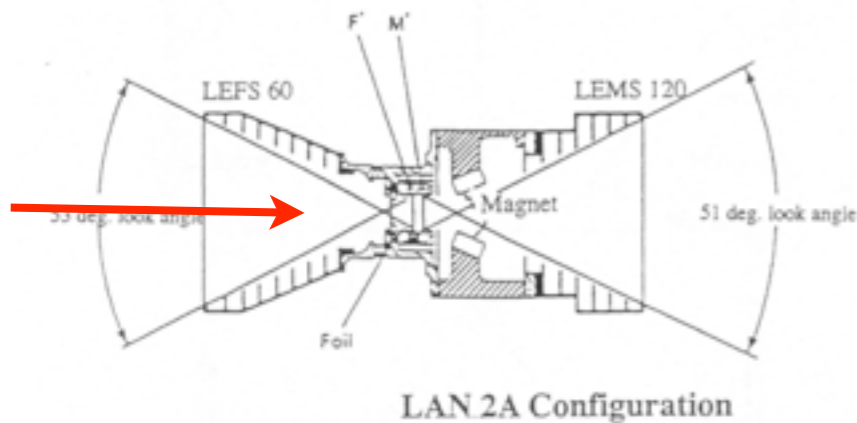

Electron Energy Deposited in Detector F'

Electron Energy Deposited in F'

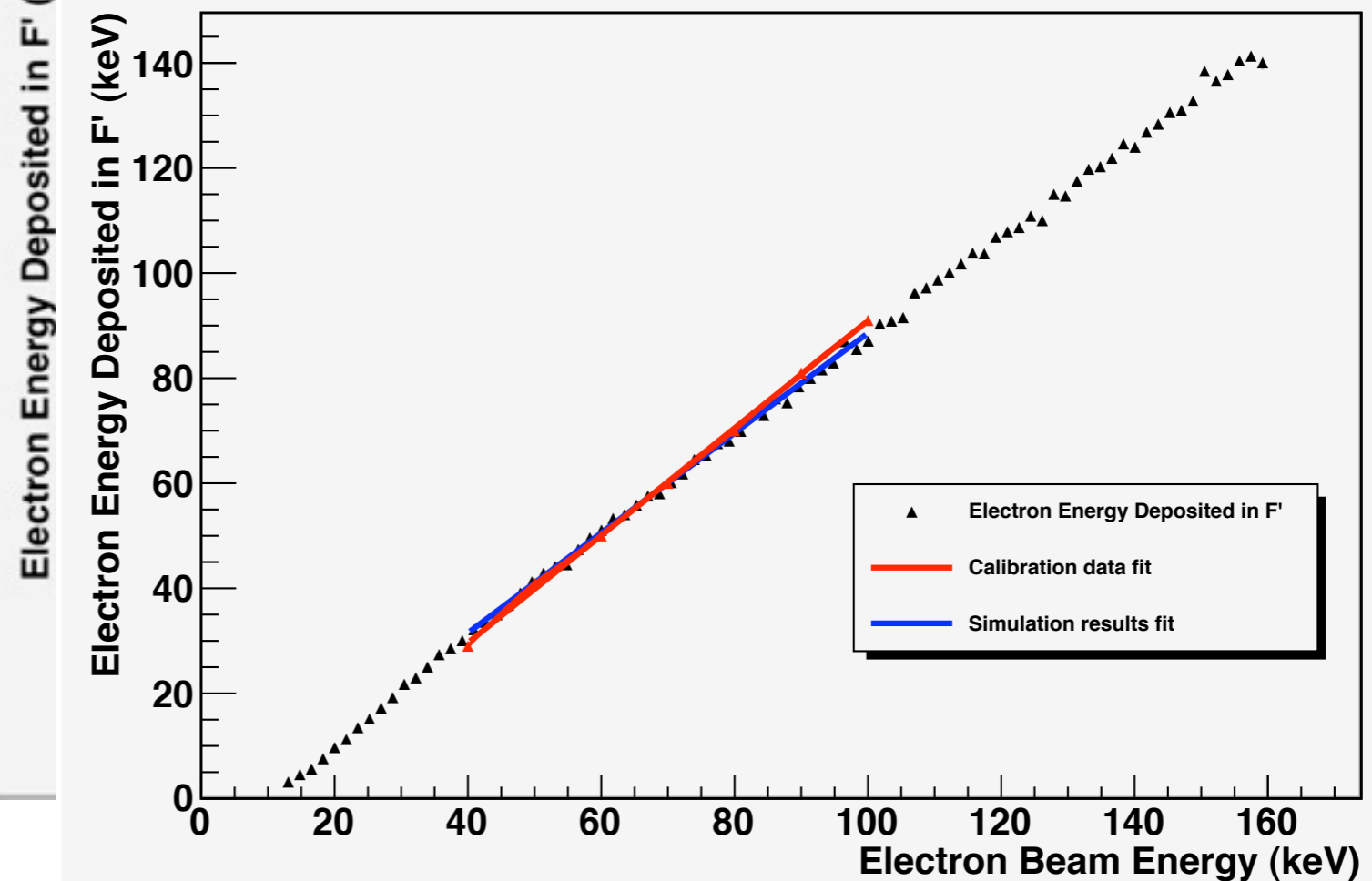

- The GEANT4 simulation reproduces the calibration data for the deposited energy in detector F.
- Electrons lose energy in the Foil.

Electronic counting thresholds Calibration

- The counting reaches 95% at about 35 keV and 100% at 40 keV.

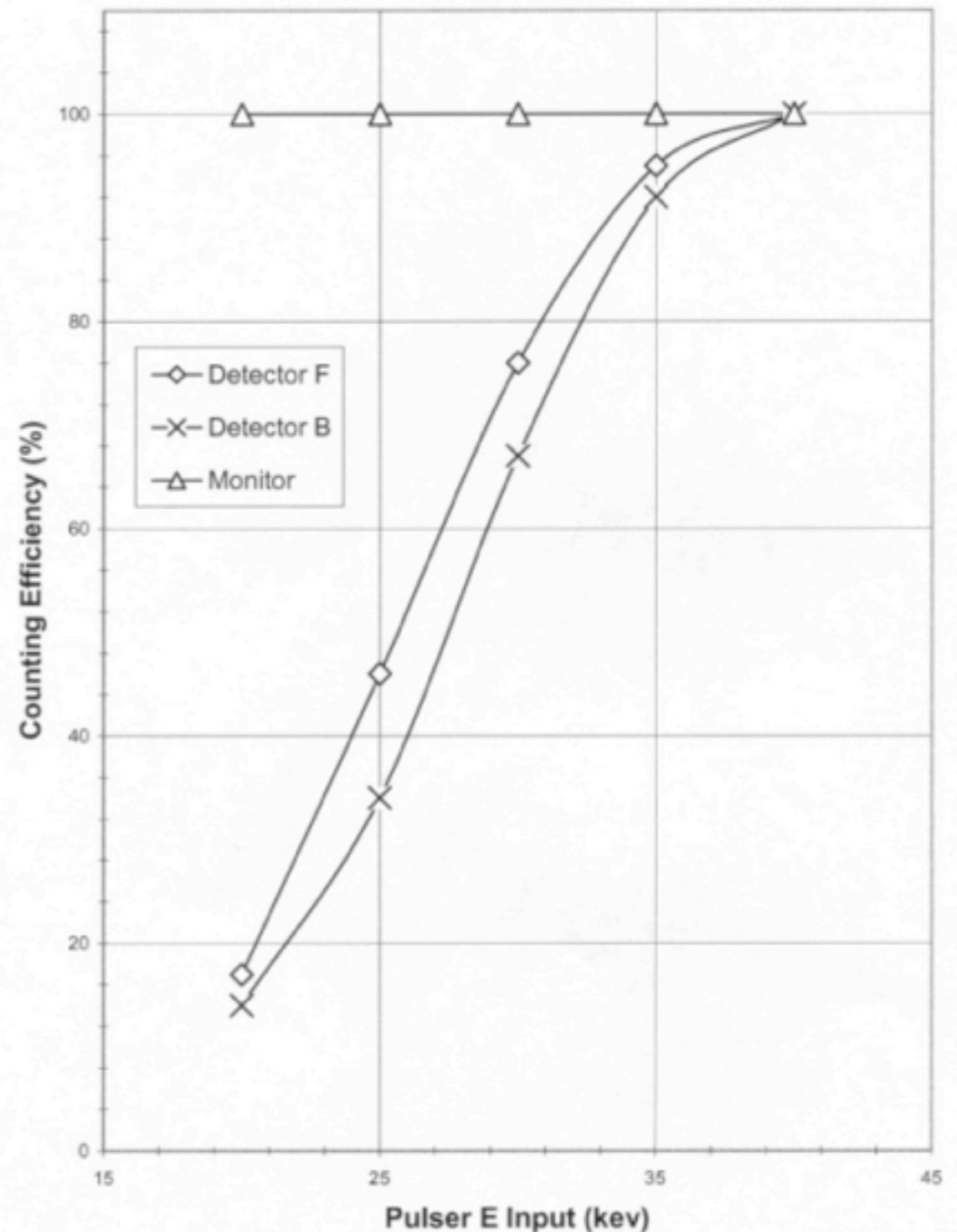

Detector F' in LEFS

Simulation of the Counting Efficiency

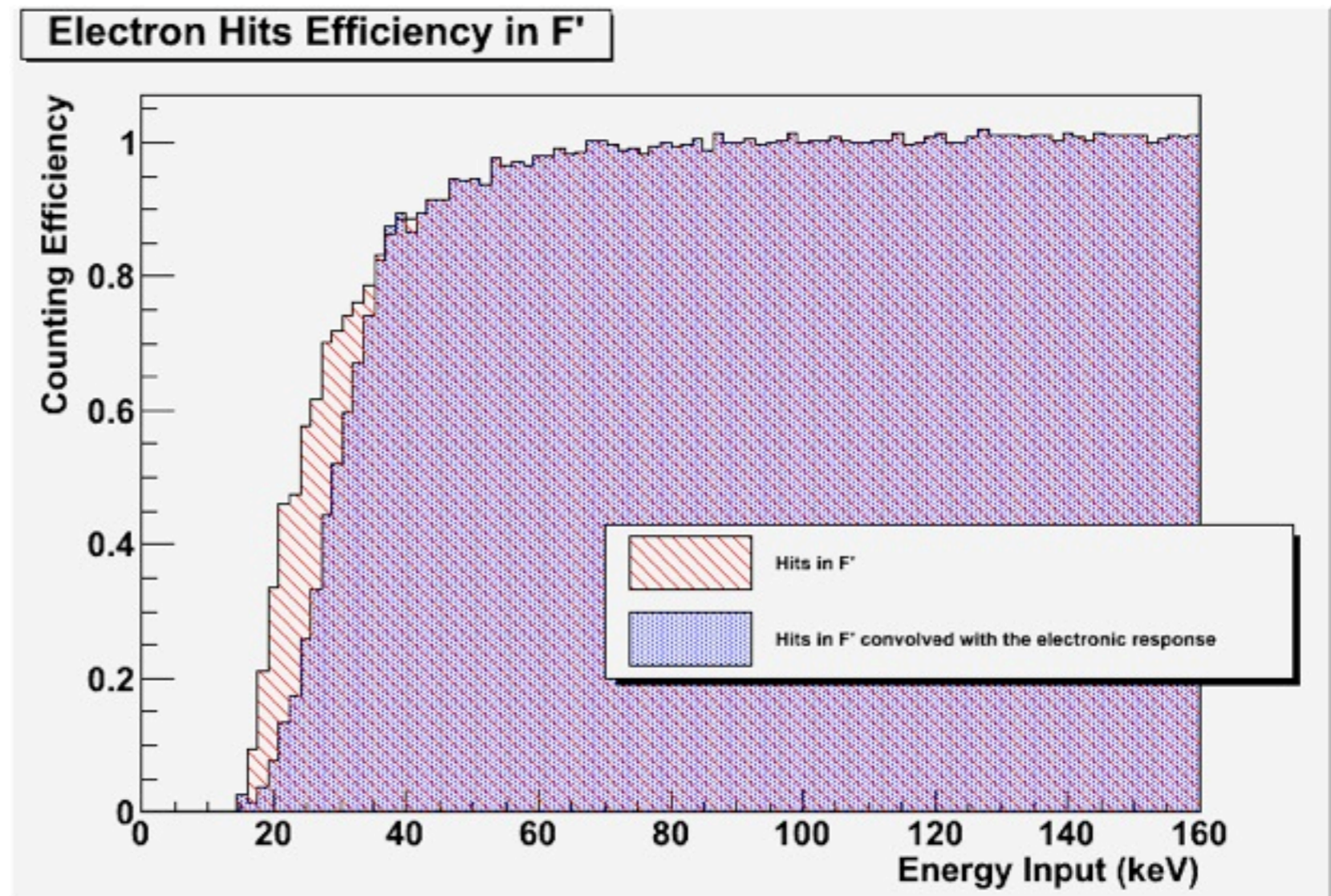
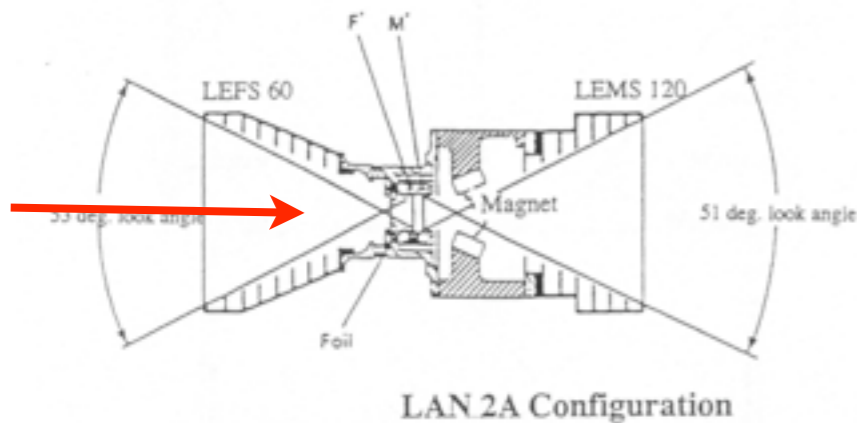

- Since we cannot simulate the electronic response in GEANT4, we added it after in our ROOT analysis.

Electron energy deposited in F'

Calibration

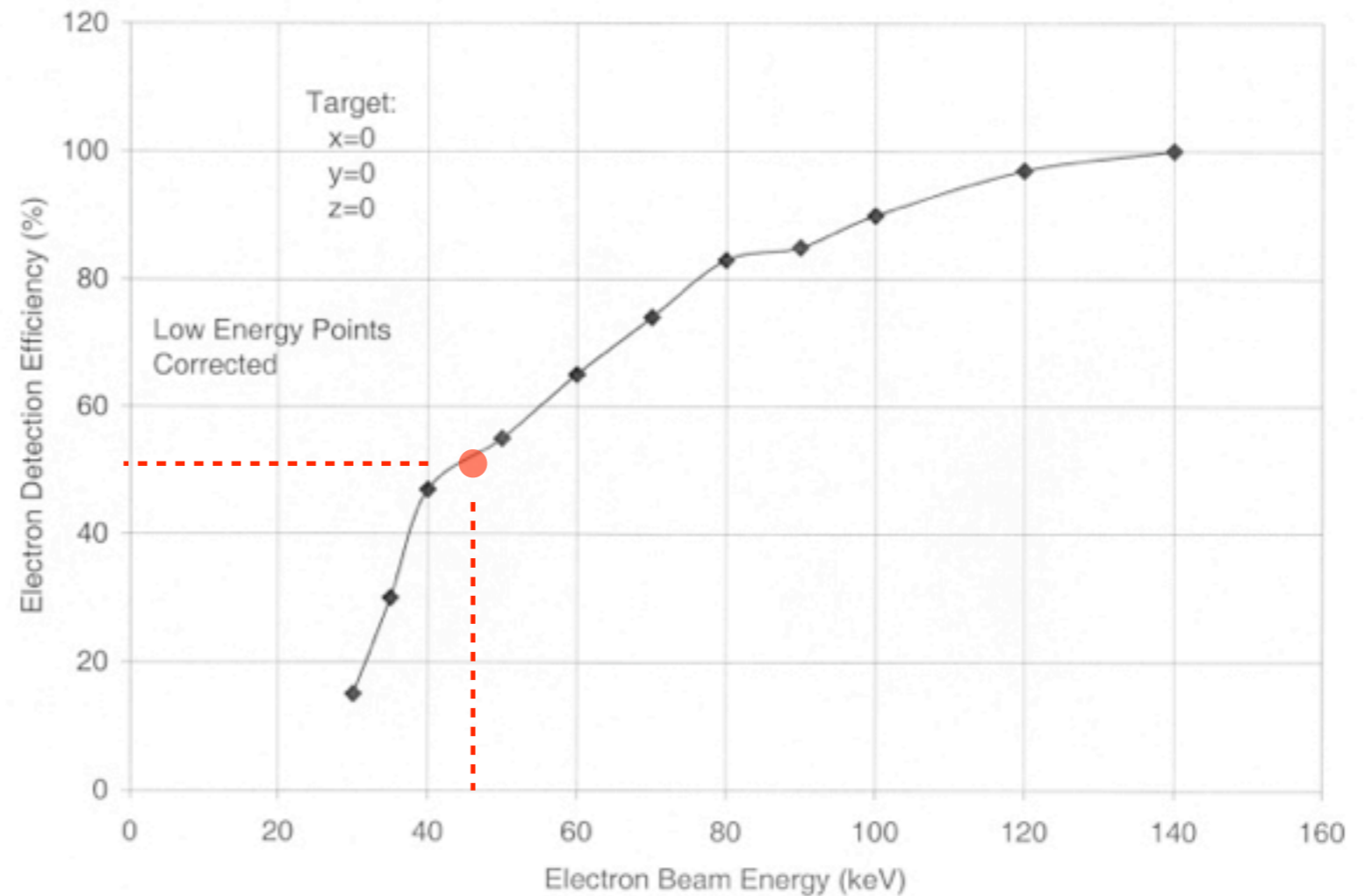
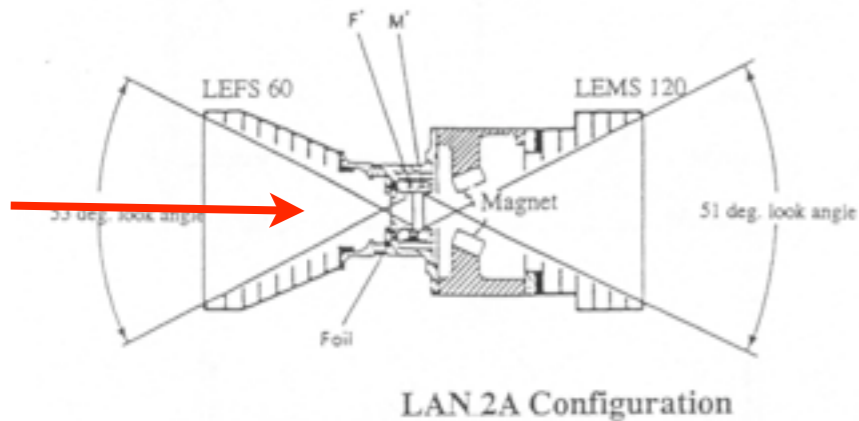

- The data points indicate a 50% energy point of approximately 45 keV.
- This will be now implemented in the hiscaleSimDetectorConstruction class.



When both the F' and M' start working

Simulation

	Channel	Logic	Passband ^a	Sectors	Accum. time(s) @ 1024 bit/s
LEFS 150 ^b	E1	F1 $\overline{F2}$ \overline{M}	30-50 keV electrons	4 ^b , 8 ^c	3 ^b , 1.5 ^c
(M, F)	E2	F2 $\overline{F3}$ \overline{M}	50-90 keV electrons	4 ^b , 8 ^c	3 ^b , 1.5 ^c
LEFS 60 ^c	E3	F3 $\overline{F4}$ \overline{M}	90-165 keV electrons	4 ^b , 8 ^c	3 ^b , 1.5 ^c
(M', F')	E4	F4 $\overline{F5}$ \overline{M}	165-300 keV electrons	4 ^b , 8 ^c	3 ^b , 1.5 ^c
~ 0.48 cm ² sr	FP5	F5 $\overline{F6}$ \overline{M}	300-550 keV ions	4 ^b , 8 ^c	6 ^b , 3 ^c
	FP6	F6 $\overline{F7}$ \overline{M}	550-1.0 MeV ions	4 ^b , 8 ^c	6 ^b , 3 ^c
	FP7	F7 \overline{M}	1.0-5.0 MeV ions	4 ^b , 8 ^c	6 ^b , 3 ^c
Singles	S1	Det. B,C,D			12
	S2	Det. M,F,M',F'			12

- Note that for high energies the electrons are being counted by both detectors.
- Still, the electronic discards electrons with energies higher than 300 keV.



When both the F' and M' start working *Simulation*

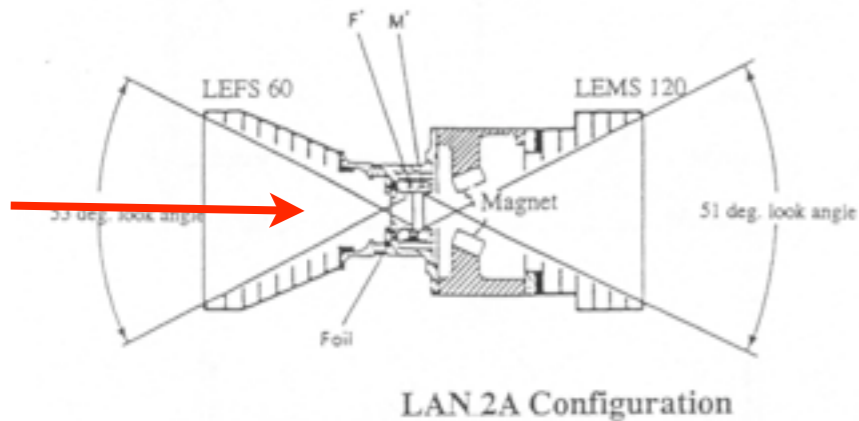

Electron Hits Efficiency in LAN2A

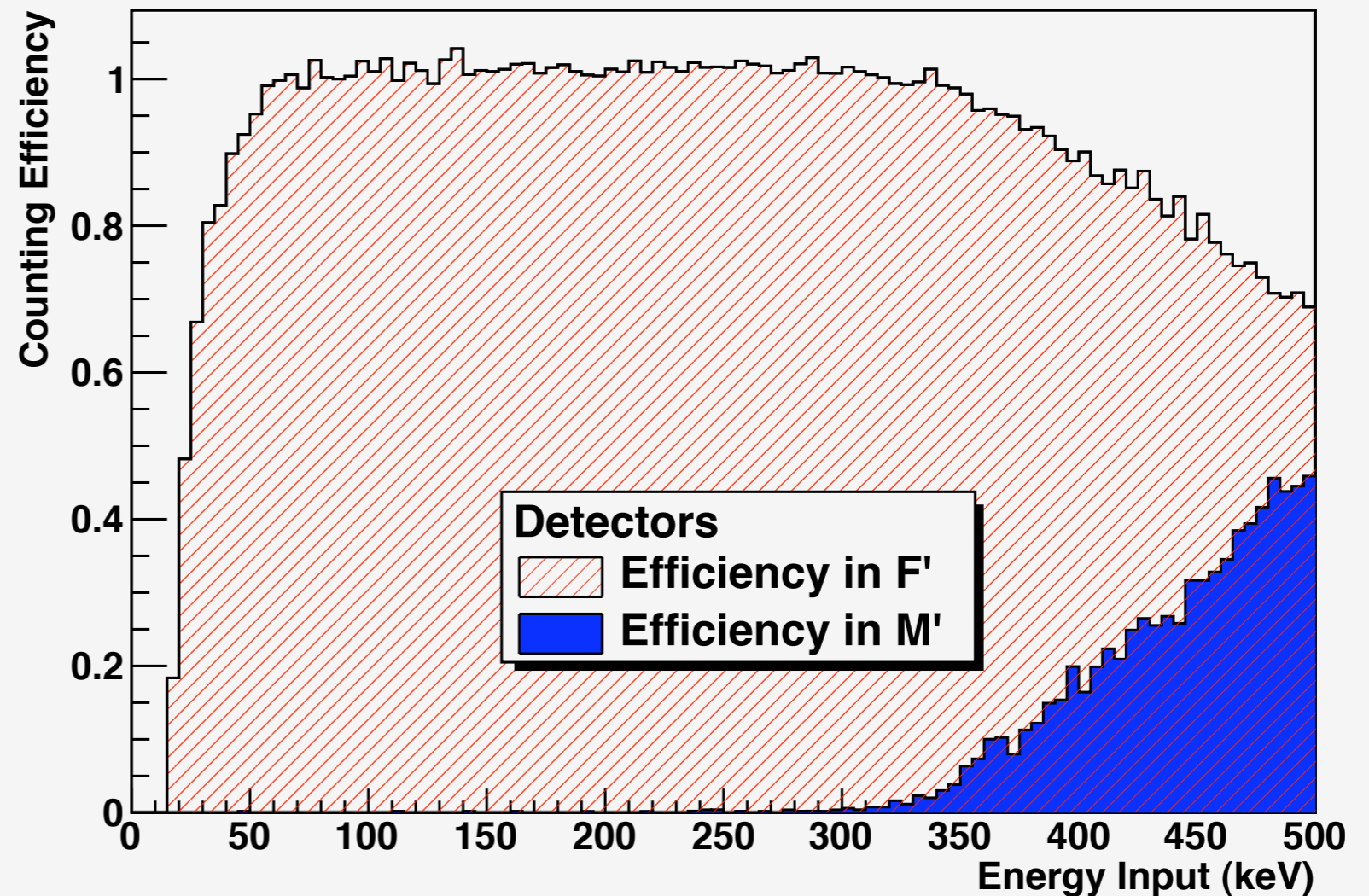

Channel	Logic	Passband ^a	Sectors	Accum. time(s) @ 1024 bit/s
LEFS 150 ^b	E1	F1 F2 M	4 ^b , 8 ^c	3 ^b , 1.5 ^c
(M, F)	E2	F2 F3 M	4 ^b , 8 ^c	3 ^b , 1.5 ^c
LEFS 60 ^c	E3	F3 F4 M	4 ^b , 8 ^c	3 ^b , 1.5 ^c
(M', F')	E4	F4 F5 M	4 ^b , 8 ^c	3 ^b , 1.5 ^c
~ 0.48 cm ² sr	FP5	F5 F6 M	4 ^b , 8 ^c	6 ^b , 3 ^c
	FP6	F6 F7 M	4 ^b , 8 ^c	6 ^b , 3 ^c
	FP7	F7 M	4 ^b , 8 ^c	6 ^b , 3 ^c
Singles	S1	Det. B,C,D		12
	S2	Det. M,F,M',F'		12

- Note that for high energies the electrons are being counted by both detectors.
- Still, the electronic discards electrons with energies higher than 300 keV.

Conclusions & Further Work

- The GEANT4 HI-SCALE / EPAM instrument simulation is almost final and undergoing validation with calibration data.
- Analysis of the data vs simulation will soon be started.
- SEP propagation models will be studied.